

Basic CPM Calculations

Overview

Time Analysis calculations in a Precedence Diagramming Method (PDM) Critical Path Method (CPM) network can be done in a number of different ways. The purpose of this White Paper is to offer a standardised set of calculations and note areas where different software tools may produce different outcomes.

Basic Definitions & Key

This White Paper uses a standard Activity Box laid out as per the ‘Key’ below. The layout of Activity nodes in commercial scheduling software is highly configurable; care needs to be taken to understand the format being used.

Activity Key and Definitions

| | | |
|-----------------------------|-----|-----|
| EST | ID | EFT |
| <i>Activity description</i> | | |
| LST | Dur | LFT |

Key:

- ID = Activity Identifier (number)
- Dur = Duration in time units
- EST = Early Start Time
- EFT = Early Finish Time
- LST = Late Start Time
- LFT = Late Finish Time

The full definition for each of these terms and the key Time Analysis calculations are:

Definitions¹

- | | |
|--------------------------|--|
| Activity Identifier (ID) | A short alphanumeric identifier, assigned to each schedule activity, to uniquely differentiate the activity from all others. The ID is typically unique within any one schedule network diagram. |
| Duration (Dur) | The total number of work periods (in calendar units) required to accomplish the work of the activity. <ul style="list-style-type: none"> - The calendar units may be singular, eg, weeks, days, minutes; or compound, eg, days and hours. - The duration may be further defined as the: <ul style="list-style-type: none"> - current (planned) duration, - actual duration (for completed work), - or a defined baseline duration. |
| Early Start Time (EST) | The earliest point in time when the schedule activity can begin (based on preceding logic and constraints). Alternative names: Early Start Date (ESD) or Early Start (ES) |

¹ Definitions are based on information in the:

- **Guide to Good Practice in the Management of Time in Complex Projects** (CIOB) and;
- **Practice Standard for Scheduling** (PMI) - See ‘References’ for more information.



| | |
|-------------------------|---|
| Early Finish Time (EFT) | The earliest point in time when the schedule activity can complete (based on preceding logic and constraints) Alternative name: Early Finish Date (EFD) or Early Finish (EF) |
| Late Start Time (LST) | The latest point in time when the schedule activity can begin so as not to delay the project completion date or any constraint. Alternative names: Late Start Date (LSD) or Late Start (LS) |
| Late Finish Time (LFT) | The latest point in time when the schedule activity can finish so as not to delay the project completion date or any constraint. Alternative names: Late Finish Date (LFD) or Late Finish (LF) |
| Free Float (FF) | Free float is the period by which an activity can shift in its timing without affecting the Early Start of any succeeding activity or event. |
| Total Float (TF) | Total float is the period by which an activity can shift in its timing without affecting the relevant schedule completion date (either a constraint, or the project completion). |
| Critical Path | The critical path is the longest sequence of activities from commencement to completion of a key date, section, or the works as a whole. In relation to each, it is that sequence of activities that will take the longest to complete or, put another way, the sequence of activities that will determine the earliest possible finish date. |

PDM Activities, Links and logic

Precedence diagrams use boxes to represent the basic network elements - the activity (or task) and lines to show the inter dependency (or links), between the activities to define the flow of work.

In precedence networks, activities:

- are identified by a activity identifier; for example, A1, A2, A3.
- have durations defining the period of time required to perform the work², and
- may have other descriptive data attached to them.

Links are usually identified by their preceding activity identifier and their succeeding activity identifier. Most links simply represent the flow of work from the completion of one activity to the start of the next. However, the effect of a link may be modified by modifying the type of link used and/or the addition of a 'Lead' or a 'Lag'.

² The duration is the number of time periods required to complete the work: eg, 2 days. This is different to the elapsed duration which is the time between the scheduled start date and scheduled finish date for the activity. A 2 day activity may have an elapsed duration of 4 days if work starts on Friday morning, the project only works 5 days per week (no work on Saturday and Sunday) and the activity completes on Monday afternoon.

For more on estimating durations see; ***The Cost of Time - or who's duration is it anyway?***
http://www.mosaicprojects.com.au/Resources_Papers_009.html



There are many different types of link³; the four basic types and the effect of applying leads and lags are described below.

Finish-to-Start Links

The normal type of link is a finish-to-start link (FS). With this type of link, the succeeding activity cannot start until after the finish of the preceding activity.

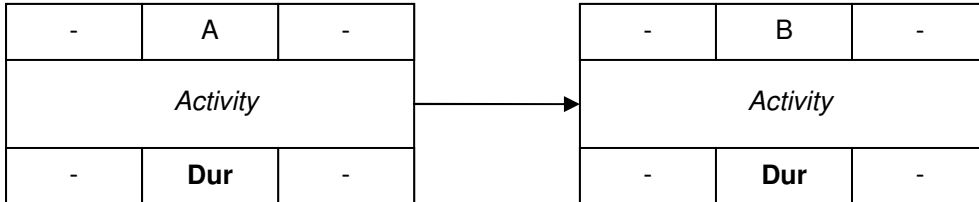

Start-to-Start Links

The start of the succeeding activity is delayed until after the start of the preceding activity. This type of dependency primarily controls the start of activities (not the finish).

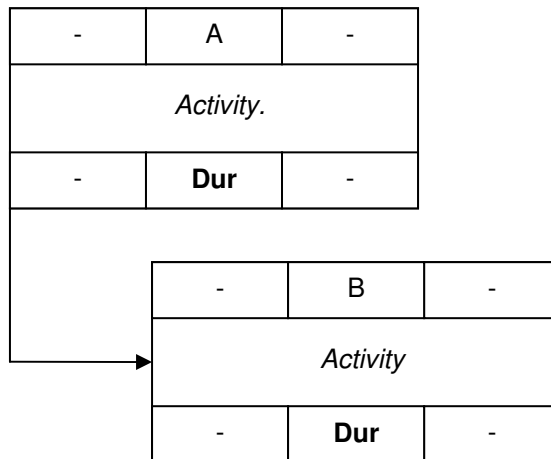

Finish-to-Finish Links

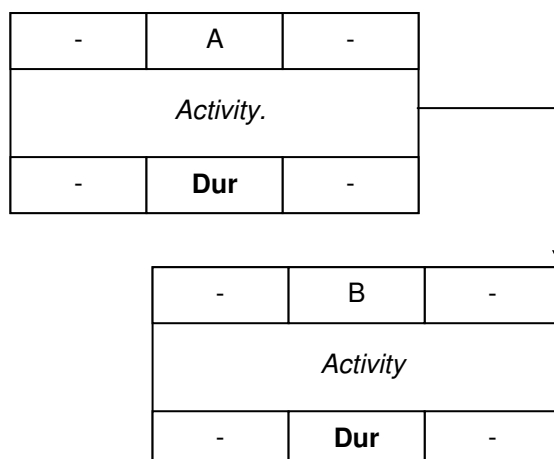

³ For more on links, see: **Links, Lags & Ladders:**
http://www.mosaicprojects.com.au/Planning.html#Core_Papers

The completion of the succeeding activity is delayed until after the completion of the preceding activity. This type of dependency primarily controls the finish of activities.

Start-to-Finish Links

The finish of the succeeding activity is constrained by the start of the preceding activity.

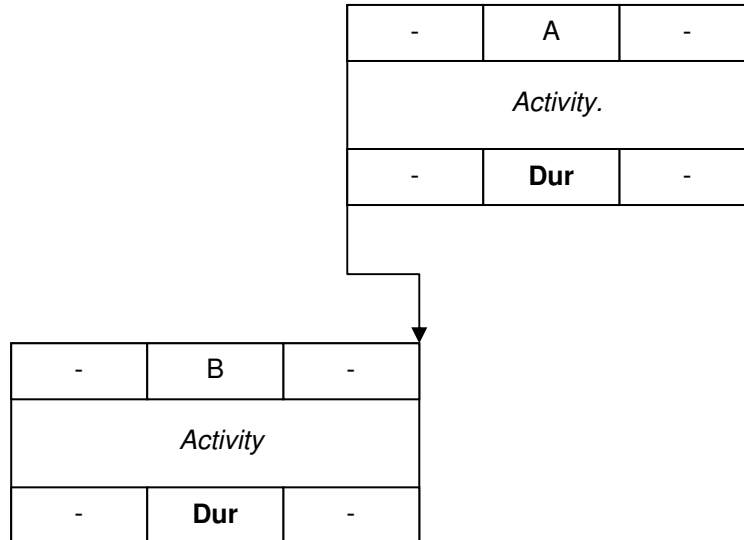

Leads and Lags applied to Links

A Lag has the effect of delaying the succeeding task by the number of time units specified. Leads (or negative lags) have the effect of accelerating the succeeding task by the number of time units specified. Negative lags (or leads) are allowed in some software packages but they need to be used with care.

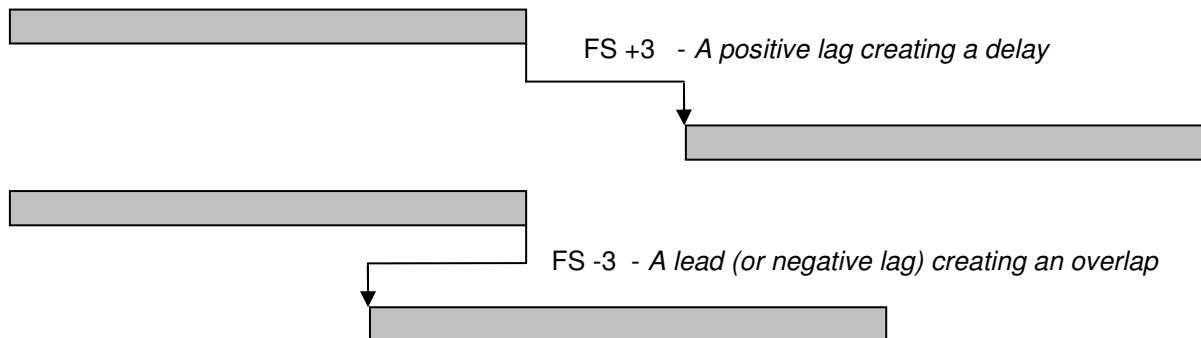

Time Analysis Processes and Overview

Forward Pass

Critical path analysis always starts with the forward pass - this calculates how soon each activity can start based on the logic of the network, the duration of the various activities and any imposed constraints. The forward pass starts at the beginning of the schedule and logically works through the schedule calculating the EST and EFT for all activities and milestones.

Backward pass

The objective of the backward pass is to calculate how late each of the activities can start and finish without delaying the completion of the overall project, or an imposed constraint. The backward pass starts at the end of the schedule and logically works from the finish to the beginning calculating the LFT and LST for all activities and milestones.

Float⁴.

For some activities, the forward pass and backward pass dates will be the same. If these activities are delayed, the whole project will finish late. Other activities will have some flexibility (called float). This opportunity to delay the timing of an activity without impacting on the project's overall completion date is one of the key tools available to the project team to resolve resource overloads and other project issues.

Time -v- Numbers, the basis of the calculations⁵

One of the basic issues associated with Time Analysis calculations is that the calculation process uses numbers, whereas *time* is a continuum. The problem is demonstrated below:

Activity A and B both take 2 days. 'A' is scheduled for Monday and Tuesday, 'B' for Wednesday and Thursday. This is easy to understand. Now let's consider the arithmetic.

Monday is 'Day 1'. Add 2 days duration to an activity starting on 'Day 1' and $1 + 2 = 3$, but the activity finishes on Tuesday which is 'Day 2'...??!!

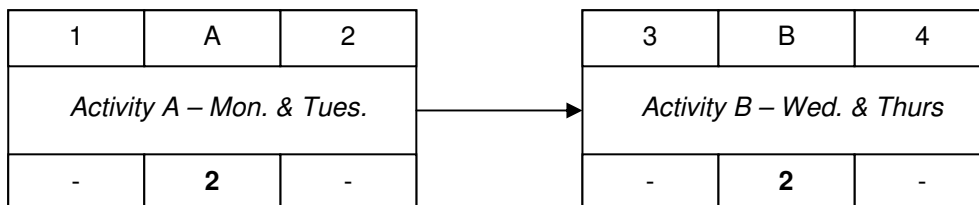

The problem is the work starts at the beginning of 'Day 1', works all of 'Day 1' then all of 'Day 2' and finishes at the end of 'Day 2'.

Similarly, the link between Activity A and B is a Finish-to-Start link with a Zero Lag. $2 + 0 = 2$ but Activity B starts at the beginning of Day 3, not the end of Day 2.

⁴ For more on Float see: **Schedule Float:**
http://www.mosaicprojects.com.au/Planning.html#Core_Papers

⁵ The calculations used in this White Paper accurately reflect the way modern scheduling software functions. Prior to the widespread adoption of PC based scheduling tools in the late 1980s critical path schedules were calculated manually using conventions that simplified the calculation process by ignoring the difference between the start and end of each day and as a consequence, allowed an error of 1 time unit to appear either on the 'Start Times' or the 'Finish Times' of each activity. For more on manual calculations see: **A Brief History of Scheduling**
http://www.mosaicprojects.com.au/Resources_Papers_042.html



This conundrum is demonstrated in the sketch below.

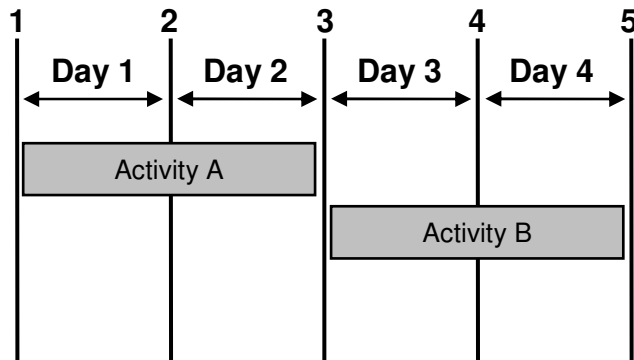

The vertical lines represent 'numbers' the space between the lines the actual time elapsing through 'Day 1', etc.

Schedule calculations need to be adjusted to compensate for the difference between the 'lines' and the space between the lines. This adjustment is automatic in all scheduling software.

To make the adjustment between 'numbers' and 'real time', schedule calculations need to be adjusted to recognise the difference between the beginning and the end of each day. The way this is achieved as follows:

'Activity A' has a 2 day duration that starts at the beginning of day 1 and finishes at the end of day 2, its finish is calculated by:

$$EFT = EST + [Duration - 1] \text{ or } 1 \text{ (start of day)} + [2 - 1] = 2 \text{ (end of day)}$$

The start of 'Activity B' is calculated by adding 1 to the Lag value on the link between the two activities to shift from the end of the preceding day to the start of the succeeding day. The calculation is:

$$EST = \text{Preceding EFT} + [\text{Lag} + 1] \text{ or } 2 \text{ (end of day)} + [0 + 1] = 3 \text{ (start of day)}$$

The Finish of 'Activity B' is calculated in the same way as 'A':

$$EFT = 3 \text{ (start of day)} + [2 - 1] = 4 \text{ (end of day)}$$

**The EST and LST values in this White Paper will be based on *the start of the day*.
The EFT and LFT values in this White Paper will be based on *the end of the day*⁶.**

⁶ **Note:** Days are used as the calendar time unit in this discussion. The problem can apply equally to any time unit; seconds, minutes, hours, weeks, if there are non working times involved in the calendars. The situation is complicated by the need to determine if the finish of an activity is at a break in the working periods or not.

Time Analysis Calculations – Single Link

Finish-to-Start Links

Forward pass;

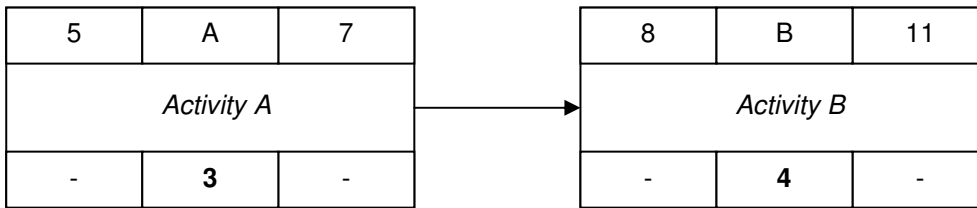

'Activity A' internal calculation. $EST + [Dur - 1] = EFT: 5 + [3 - 1] = 7$

Link calculation. 'Activity A' EFT + [Lag + 1] = 'Activity B' EST: $7 + [0 + 1] = 8$

'Activity B' internal calculation. $EST + [Dur - 1] = EFT: 8 + [4 - 1] = 11$

Backward pass;

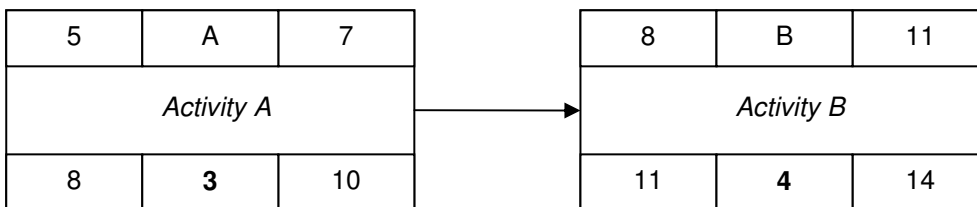

'Activity B' internal calculation. $LFT - [Dur - 1] = LST: 14 - [4 - 1] = 11$

Link calculation. 'Activity B' LST - [Lag + 1] = 'Activity A' LFT: $11 - [0 + 1] = 10$

'Activity A' internal calculation. $LFT - [Dur - 1] = LST: 10 - [3 - 1] = 8$

The effect of a Lag;

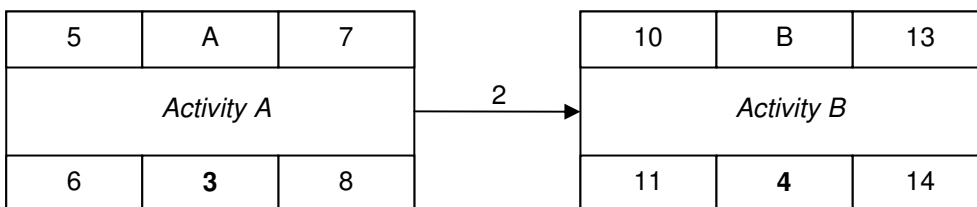

Link calculation; forward pass.

'Activity A' EFT + [Lag + 1] = 'Activity B' EST: $7 + [2 + 1] = 10$

Link calculation; backward pass.

'Activity B' LST - [Lag + 1] = 'Activity A' LFT: $11 - [2 + 1] = 8$

Start-to-Start (SS) Links

Forward pass;

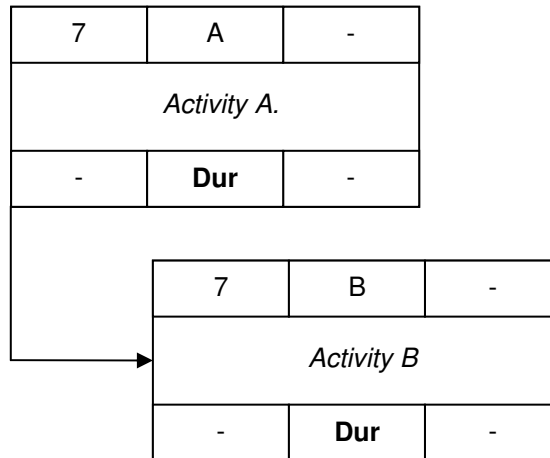

Link calculation. 'Activity A' EST + [Lag] = 'Activity B' EST: $7 + [0] = 7$

Backward pass;

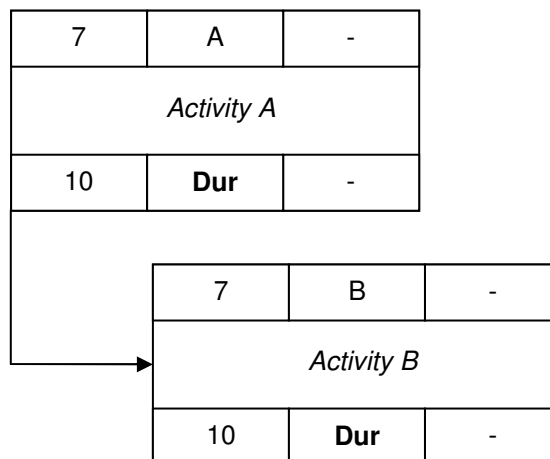

Link calculation. 'Activity B' LST - [Lag] = 'Activity A' LST: $10 - [0] = 10$

Note: if leads are used (negative lags) the calculations remain the same for FF and SS links, remembering to change the + and - signs appropriately.

The effect of a Lag;

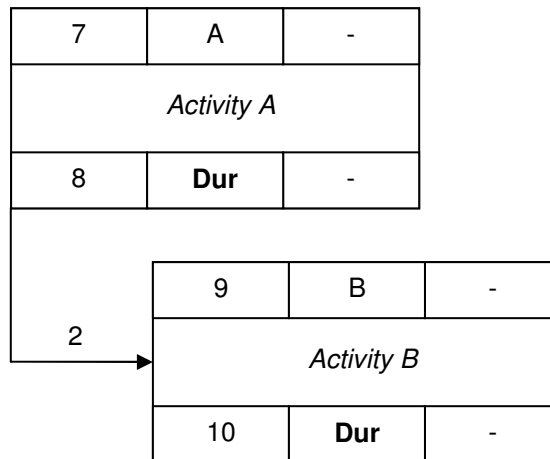

Link calculation; forward pass.

$$\text{'Activity A' EST} + [\text{Lag}] = \text{'Activity B' EST}: 7 + [2] = 9$$

Link calculation; backward pass.

$$\text{'Activity B' LST} - [\text{Lag}] = \text{'Activity A' LST}: 10 - [2] = 8$$

Note: The SS link connects the ‘start-of-day’ in the preceding task to the ‘start-of-day’ in the succeeding task; therefore there is no need to adjust the calculation. The internal calculations remain as defined above.

Finish-to-Finish (FF) Links

Forward pass;

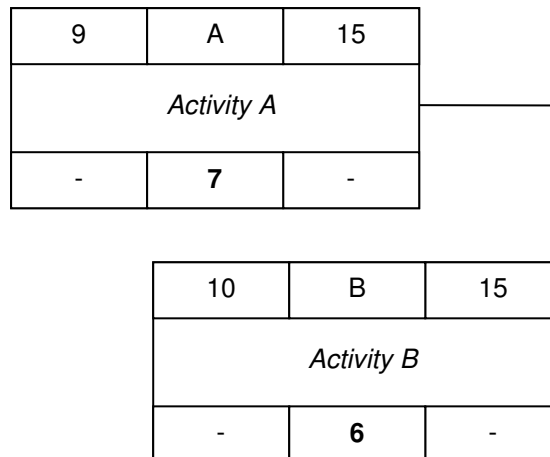

$$\text{'Activity A' internal calculation. EST} + [\text{Dur} - 1] = \text{EFT}: 9 + [7 - 1] = 15$$

$$\text{Link calculation. 'Activity A' EFT} + [\text{Lag}] = \text{'Activity B' EFT}: 15 + [0] = 15$$

$$\text{'Activity B' internal calculation. EFT} - [\text{Dur} - 1] = \text{EST}: 15 - [6 - 1] = 10$$

Backward pass;

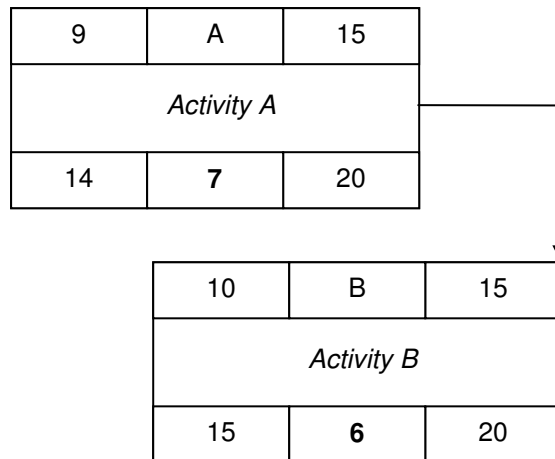

'Activity B' internal calculation. $LFT - [Dur - 1] = LST: 20 - [6 - 1] = 15$

Link calculation. 'Activity B' $LFT - [Lag] = \text{'Activity A' LFT}: 20 - [0] = 20$

'Activity A' internal calculation. $LFT - [Dur - 1] = LST: 20 - [7 - 1] = 14$

The effect of a Lag;

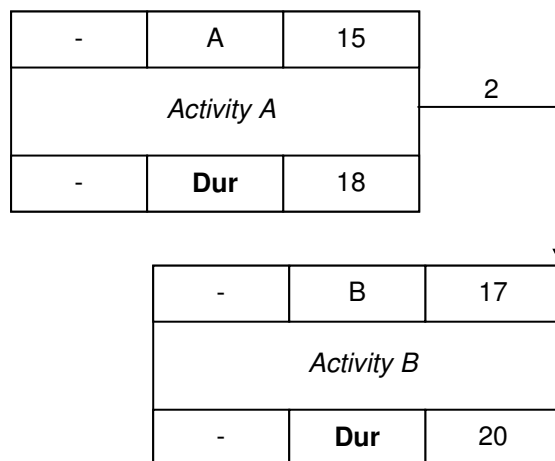

Link calculation; forward pass.

'Activity A' $EFT + [Lag] = \text{'Activity B' EFT}: 15 + [2] = 17$

Link calculation; backward pass.

'Activity B' $LFT - [Lag] = \text{'Activity A' LFT}: 20 - [2] = 18$

Note: The FF link connects the 'end-of-day' in the preceding task to the 'end-of-day' in the succeeding task; therefore there is no need to adjust the calculation. The internal calculations remain as defined above.

Start-to-Finish Links

Forward pass;

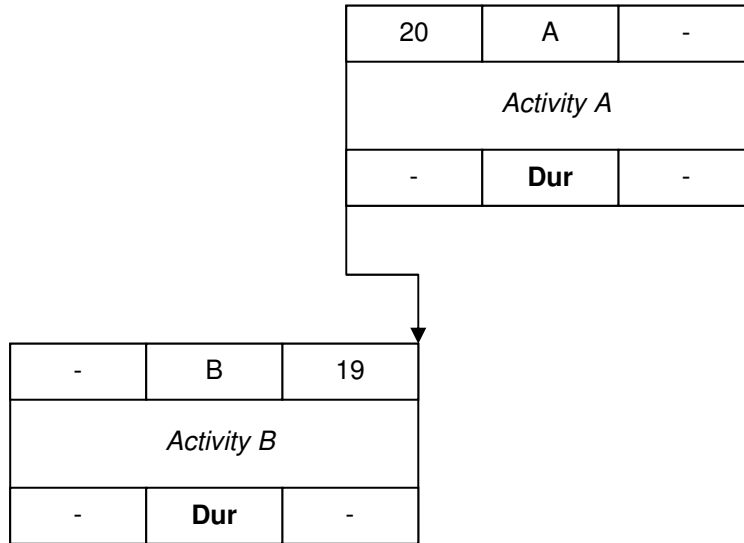

Link calculation. 'Activity A' EST + [Lag - 1] = 'Activity B' EFT: $20 + [0 - 1] = 19$

Backward pass;

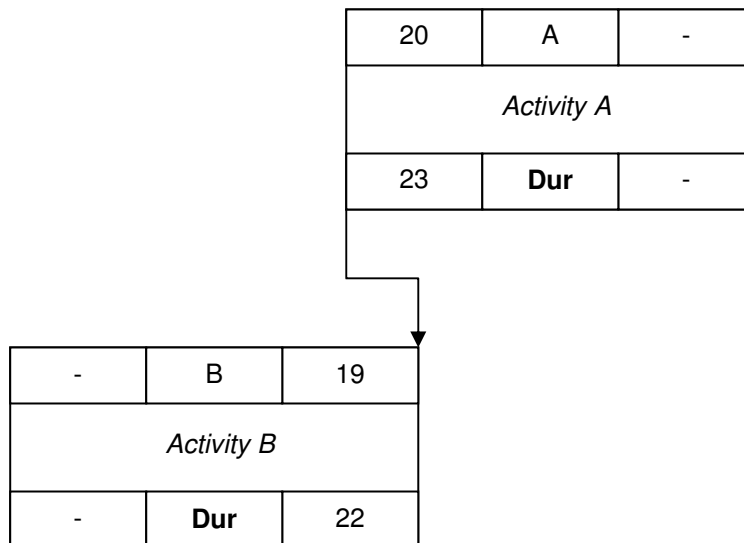

Link calculation. 'Activity B' LFT - [Lag - 1] = 'Activity A' LST: $22 - [0 - 1] = 23$

The effect of a Lag;

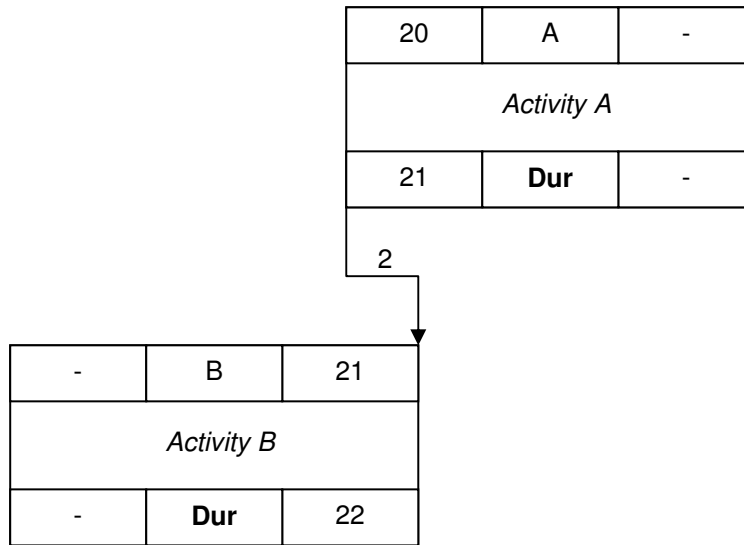

Link calculation; forward pass.

$$\text{'Activity A' EST} + [\text{Lag} - 1] = \text{'Activity B' EFT: } 20 + [2 - 1] = 21$$

The work of the activities overlaps for two days from then beginning of day 20 to the end of day 21

Link calculation; backward pass.

$$\text{'Activity B' LFT} - [\text{Lag} - 1] = \text{'Activity A' LFT: } 22 - [2 - 1] = 21$$

Note: The SF link connects the 'Start-of-day' in the preceding task to the 'end-of-day' in the succeeding task; therefore it has to be adjusted in the same way as Finish-to-Start links. The internal calculations remain as defined above.

Constraints⁷

Constraints override schedule calculations in the following circumstances.

Fixed Constraints

The early and late dates are both fixed at the constrained date. The constraint may be placed on the start or the finish of the activity and when combined with a fixed duration set all four analysis dates on the activity. The constraint's effect in time analysis is as follows:

- The Forward Pass on preceding activities is not affected.
- The Forward Pass on successor activities starts from the fixed date.
- The Backward pass on successor is not affected.
- The Backward pass on preceding activities starts from the fixed date.

Start-No-Earlier-Than Constraints

The early start date is fixed at the constrained date. The constraint is placed on the start of the activity and prevents the activity being scheduled earlier than the constraint date. The constraint's effect in time analysis is as follows:

- The Forward Pass on preceding activities is not affected.
- The Forward Pass EST on the activity starts from the fixed date or from the analysed dates, whichever is later.
- The Backward pass is not affected (Negative float is still calculated).

Finish-No-Later-Than Constraints

The late finish date is fixed at the constrained date. The constraint is placed on the finish of the activity and prevents the activity being scheduled later than the constraint date. The constraint's effect in time analysis is as follows:

- The Forward Pass on preceding activities is not affected.
- The Forward Pass EFT on the activity starts from the fixed date or from the analysed dates, whichever is earlier (this is tool dependent).
- The Backward pass on successor activities is not affected.
- The Backward pass LFT on the activity starts from the fixed date or from the analysed dates, whichever is earlier.

As-Soon-As-Possible Constraints⁸

The LST and LFT analysis dates are set equal to EST and EFT. This creates a 'Zero Float' critical path between the activity and the project start (or another controlling constraint).

As-Late-As-Possible Constraints

The EST and EFT analysis dates are set equal to LST and LFT. This creates a 'Zero Float' critical path between the activity and the project completion (or another constraint).

⁷ There are many other constraints available (depending on the tool), and the way the constraints affect scheduling is tool dependent - before using any constraint you need to understand how it is applied in the tool you are using. For the PMI-SP exam, the definitions in the *Practice Standard for Scheduling* apply (the definitions in **The Guide**, used as a reference in our PMI-SP training course, are consistent with the PMI definitions).

⁸ Note: Microsoft Project places a different meaning on 'As-Soon-As-Possible' which is inconsistent with the normal definition used in this White Paper.

Time Analysis Calculations - Complex

The single link calculations above remain constant. However, where there are more than one preceding or succeeding links, or constraints have been imposed, the calculations need to take account of the different potential outcomes. The consistent policy is to use the ‘worst case’ option. This means using the latest dates in any forward pass calculation and the earliest date in any backward pass calculation. The activity duration for all normal activities remains fixed.

Multiple Predecessors and/or Successors

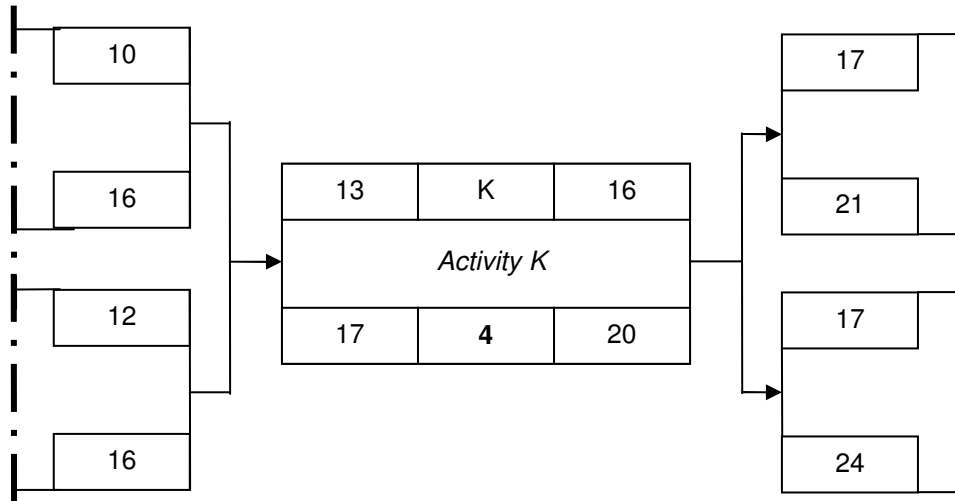

Forward Pass calculation

The EST of Activity K is determined by the latest EFT of its predecessors. All of the logical constraints must be honoured; therefore the ‘biggest number’ is used in the calculation.

$$\text{EST} = \text{predecessor (max): EFT} + [\text{Lag} + 1]: 12 + \{0 + 1\} = 13$$

Backward pass calculation

The LFT of Activity K is determined by the earliest LST of its successors. All of the logical constraints must be honoured; therefore the ‘smallest number’ is used in the calculation.

$$\text{LFT} = \text{successor (min) LST} - [\text{Lag} + 1]: 21 - [0 + 1] = 20$$

Overlapping Activities & Ladders⁹

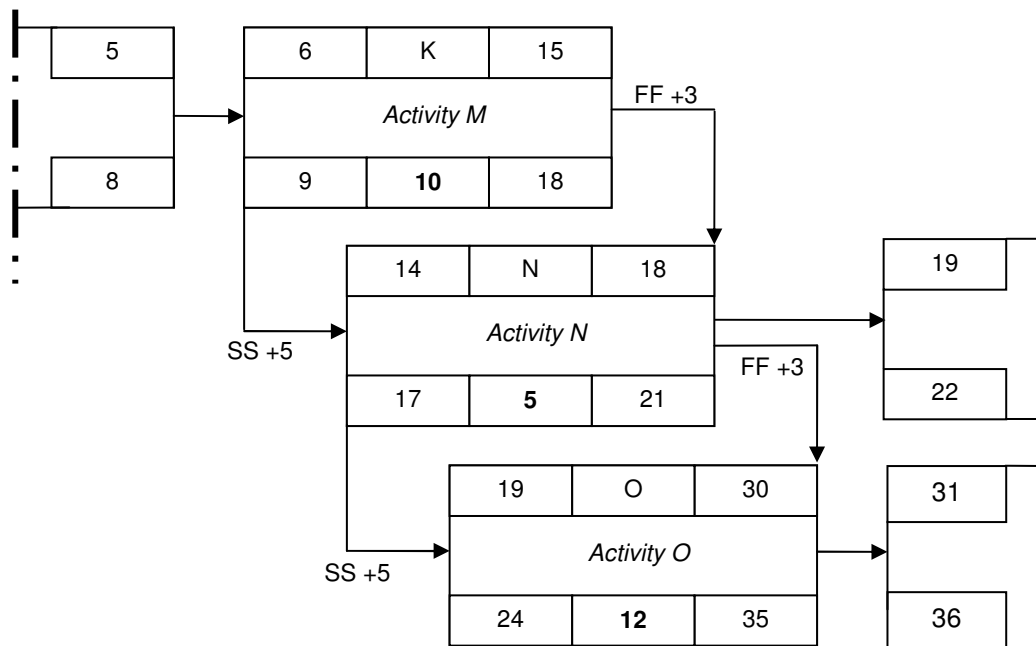

Forward Pass calculation

The EST of Activity N is determined by the 'worst case' situation.

The calculation based on the SS link from Activity M is: $EST: 6 + 5 = 11$

The calculation based on the FF link is $EFT: 15 + 3 = 18$

To honour the activity duration of 5 days, the Finish-to-Finish link requires the EST to be

$$EFT - [Dur - 1]: 18 - [5 - 1] = 14$$

This is later than the Start-to-Start link and 14 is used as the 'worst case' option. The delayed start of Activity N then controls the timing of Activity O; this effect is sometimes called 'lag drag'. To avoid 'lag drag' either split Activity N into two separate activities or change its characteristics (type¹⁰) to allow the duration to stretch.

Backward pass calculation

The LFT of Activity N is determined by the earliest LST of its successors. All of the logical constraints must be honoured; therefore the 'smallest number' is used in the calculation; in this case the LST of 22 on the FE link. The LST of Activity N is based on its duration $21 - (5 - 1) = 17$. The 'late times' of Activity M are controlled through the FF link.

⁹ See also **Scheduling Core Paper #4: Links, Lags and Ladders:**
http://www.mosaicprojects.com.au/PDF/Links_Lags_Ladders.pdf

¹⁰ Some scheduling tools implement 'Ladders' effectively by using the concept of 'progressive feed' to allow each activity to start at its earliest timing and avoid 'lag drag'. For one example see Micro Planner at: <http://www.mosaicprojects.com.au/Tools.html#Xpert>

Progress Calculations

The same basic calculations described above are used to calculation the situation after a status update¹¹. Typically actual start dates are recorded for all activities actually started. Finish dates for all activities actually complete and the amount of time required to complete all in-progress activities. The time to complete is assessed on the same basis as the duration, the net amount of working time. All incomplete work is then re-scheduled from the status date or time.

Out-of-Sequence Progress

When stautising and updating a schedule to record progress, particular care is needed to ensure the logic between overlapping activities is still appropriate for the actual progress of the work. Many tools offer the option to either maintain logic (preferred) or override logic. Before analysing the schedule, the best general setting should be selected and then specific adjustments are made to ensure the network accurately models the intended pattern of work. The example below shows the same set of activities with ‘logic override’ selected on the left, and ‘maintain logic’ selected on the right.

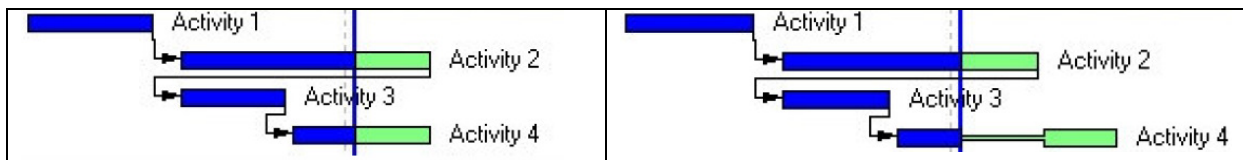

Where ‘maintain logic’ is selected all of the preceding links and activities are considered to determine the earliest date/time the remaining part of ‘Activity 4’ can start. This may involve a sequence of partially complete work if there are a string of activities partially complete and generally provides a more accurate assessment of the situation than using ‘logic override’.

Float Calculations¹²

Positive float values are an indication of the degree of scheduling flexibility in the schedule for use in subsequent analysis processes associated with resource smoothing and levelling and/or to absorb performance delays associated with the work on activities with calculated float. Float is not ‘spare time’ it is a creation of the CPM schedule development process.

¹¹ For more on stautising and updating a schedule see, **A Guide to Scheduling Good Practice:** http://www.mosaicprojects.com.au/Planning.html#Core_Papers

¹² For more on Float see, **Schedule Float:** http://www.mosaicprojects.com.au/Planning.html#Core_Papers

Total Float

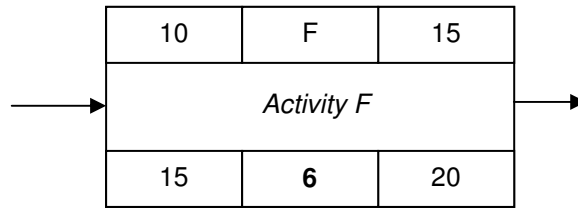

Total float is the time an activity can be delayed without delaying the overall schedule completion or a constraint. It is calculated by deducting the EFT from the LFT for each activity.

$$\text{Total float for Activity F} = \text{LFT} - \text{EFT}: 20 - 15 = 5$$

If there are start and finish constraints on the activity, a more accurate calculation that is always correct is:

$$\text{Total float for Activity F} = (\text{LFT} - \text{EST}) - \text{Dur.} + 1^{13}: (20 - 10) - 6 + 1 = 5$$

Negative Total Float

Negative total float is caused when an imposed constraint (date) requires an activity to be achieved before its scheduled completion date calculated on the forward pass.

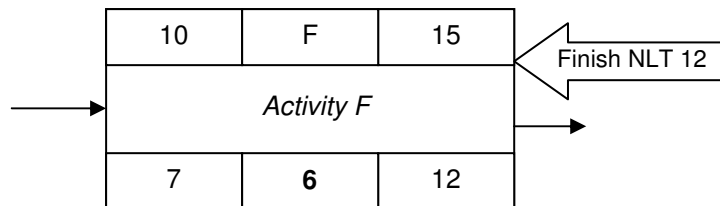

The requirement imposed on Activity F to ‘finish no later than’ 12 changes the Total Float calculation to:

$$\text{LFT} - \text{EFT}: 12 - 15 = -3.$$

The negative float value indicates three days need to be removed from the logic preceding Activity F to allow the constraint to be honoured.

Or using the more complex ‘always correct’ calculation is:

$$(\text{LFT} - \text{EST}) - \text{Dur.} + 1: (12 - 10) - 6 + 1 = 3$$

¹³ The ‘+1’ is needed to add back the day that is deducted in the normal calculations for forward and back passes to adjust for the ‘beginning and end of day’ problem (See **Time -v- Numbers** above – page 5).

Free Float¹⁴

Free float is the time an activity can be delayed without delaying the earliest start of any succeeding activity or event, or violating a schedule constraint. The only activity with free float in the diagram below is Activity V.

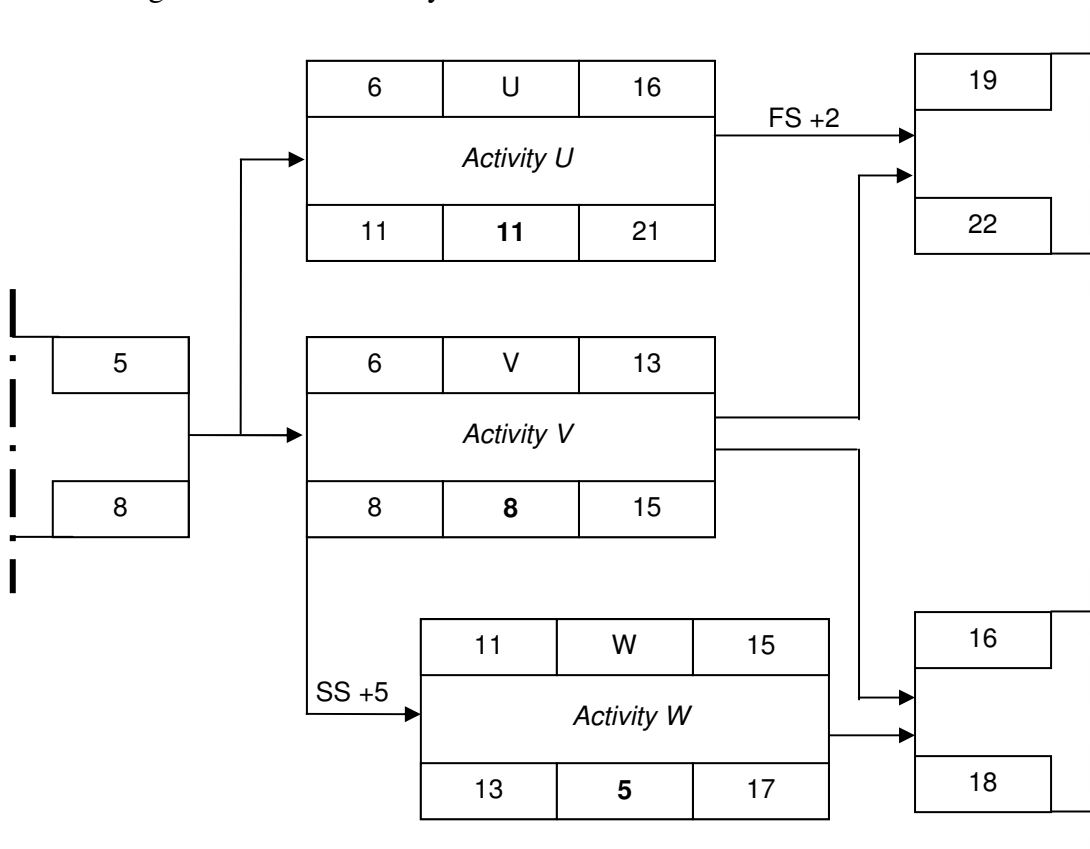

The calculation for Free Float is based on the earliest Early Start of an activity's successors. The earliest EST is 16.

$$\text{Free Float Activity V} = (\text{Successor ESTmin}) - [\text{Lag} + 1] - \text{EFT} = 16 - [0 + 1] - 13 = 2$$

$$\text{A similar calculation for Activity U yields } 19 - [2 + 1] - 16 = 0$$

$$\text{A similar calculation for Activity W yields } 16 - [0 + 1] - 15 = 0$$

Note: Activity V's LST and LFT are based on the SS link from Activity W through the SS link.

Calendars

Calendars do not effect the basic calculations defined in this White Paper. Calendars define when, during the course of the project work may occur and when it may not. A duration of 2 days working time (used in the calculations) may convert to an elapsed duration of 4 days if work starts on Friday morning, the project only works 5 days per week (no work on Saturday and Sunday) and the activity completes on Monday afternoon.

Schedule calculations are based on working time and then converted to actual dates based on the calendar selected for the activity. This requires the computer software to understand the

¹⁴ For more on Free Float see, **Schedule Float:** http://www.mosaicprojects.com.au/Planning.html#Core_Papers

working times available in the preceding activities calendar, the working times available in the link's calendar if there is a lag and the working times available in the succeeding activities calendar. With a simple, single calendar this can be done by numbering the working days. As soon as multiple calendars are used either with different working days an/or the length of the working day changes, the calculations become very complex.

One example is changes in the allocated calendar may cause different float values to appear in the same sequence of activities (or may not). A classic example is when an activity working on a 7 day calendar is succeeded by an activity working on a 5 day calendar. If the '7 day' activity finishes on Friday evening, its successor cannot start until Monday morning (based on the 5 day calendar) and the '7 day' activity will show 2 days additional Float compared to its immediate successor. This is caused by the fact the '7 day' activity can finish on Friday, Saturday or Sunday without affecting the start of the succeeding activity on Monday morning. Move the activities forward one day so the 7 day activity can finish on Thursday and the '5 day' successor start on Friday the float values return to normal.

Multiple calendars are useful, but need to be used with care.

Basic ADM Calculations

Arrow Diagramming Method (ADM) calculations are based on the events (or Nodes) at the start and end of each activity. The 'arrows' represent the Activity with its associated duration. The two basic rules are:

- An activity cannot start until its preceding event is achieved.
- An event is not achieved until all of its preceding activities are complete.

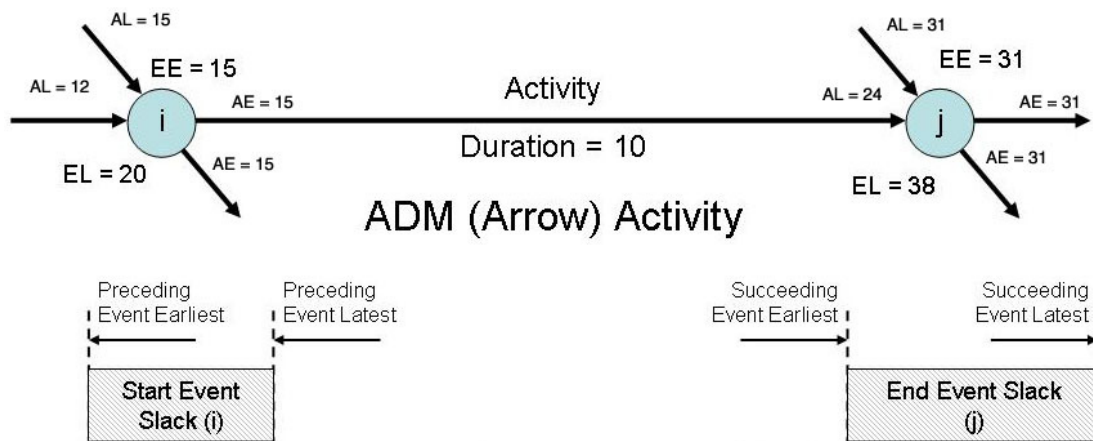

The Forward Pass calculations are:

- The Event Early is the latest of the preceding activities Early Finish
- The Activity Early Start is equal to the preceding Event Early.

The Backward pass calculations are similar:

- The Event Late is the earliest of the succeeding activities Late Starts

- The Activity Late Finish is equal to the succeeding event latest.

The ADM data structure allows far more sophisticated float calculations, for more on this see: http://www.mosaicprojects.com.au/PDF/Schedule_Float.pdf

PDM Analysis using different settings for calculation

This model is designed to show the difference between two calculation settings in the same PDM network. In both models, the calculation is based on the activity starting at the beginning of the day and finishing at the end of the day, therefore a two day activity will start at the beginning of Day 1, work for Day 1 and Day 2 (2 days duration) and finish at the end of Day 2, its successor starts at the beginning of Day 3 (assuming a Zero duration Finish-to-Start link).

Key:

| | | |
|-----|-----|-----|
| EST | Dur | EFT |
| TFE | | TFL |
| LST | ID | LFT |

EST = Early Start Time
 EFT = Early Finish Time
 LST = Late Start Time
 LFT = Late Finish Time
 Dur = Duration
 ID = Activity ID
 TFE = Total Float Early
 TFL = Total Float Late

Model 1 – Standard PDM Analysis

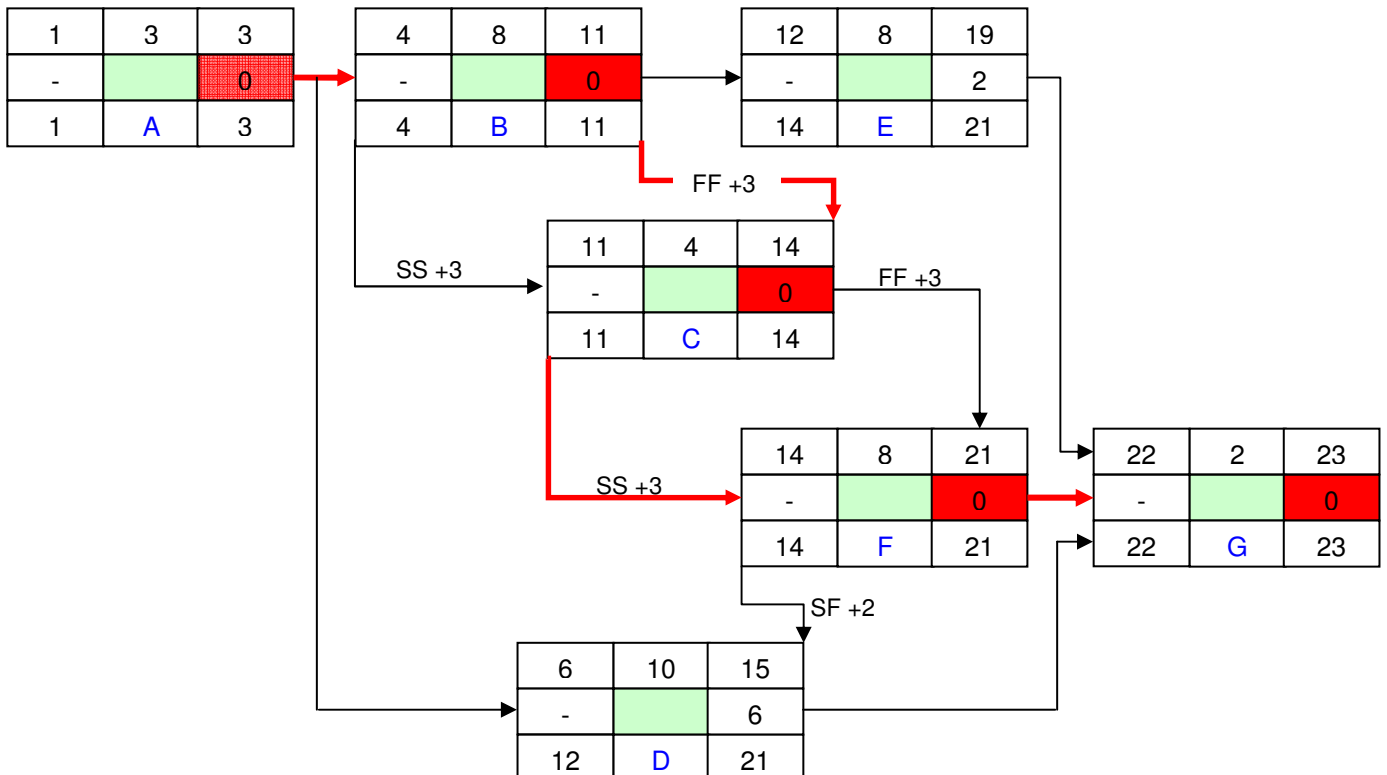

Standard PDM calculations are based on the premise the activity duration is fixed (or contiguous) and the difference between each activities start time and finish time, on both the forward and back passes, is the duration. Therefore, there can only be one 'float value' calculated for each activity.

The consequence of this analysis model can be seen in the 'ladder' between Activities B, C and F where the Finish-to-Finish link from 'B' drags the activity back with a consequential delay to the start of 'F'. This effect has been called 'lag drag'. This mode of analysis is the default standard in most software tools used for schedule analysis.

Model 2 – Event Focused PDM Analysis (interruptible durations)

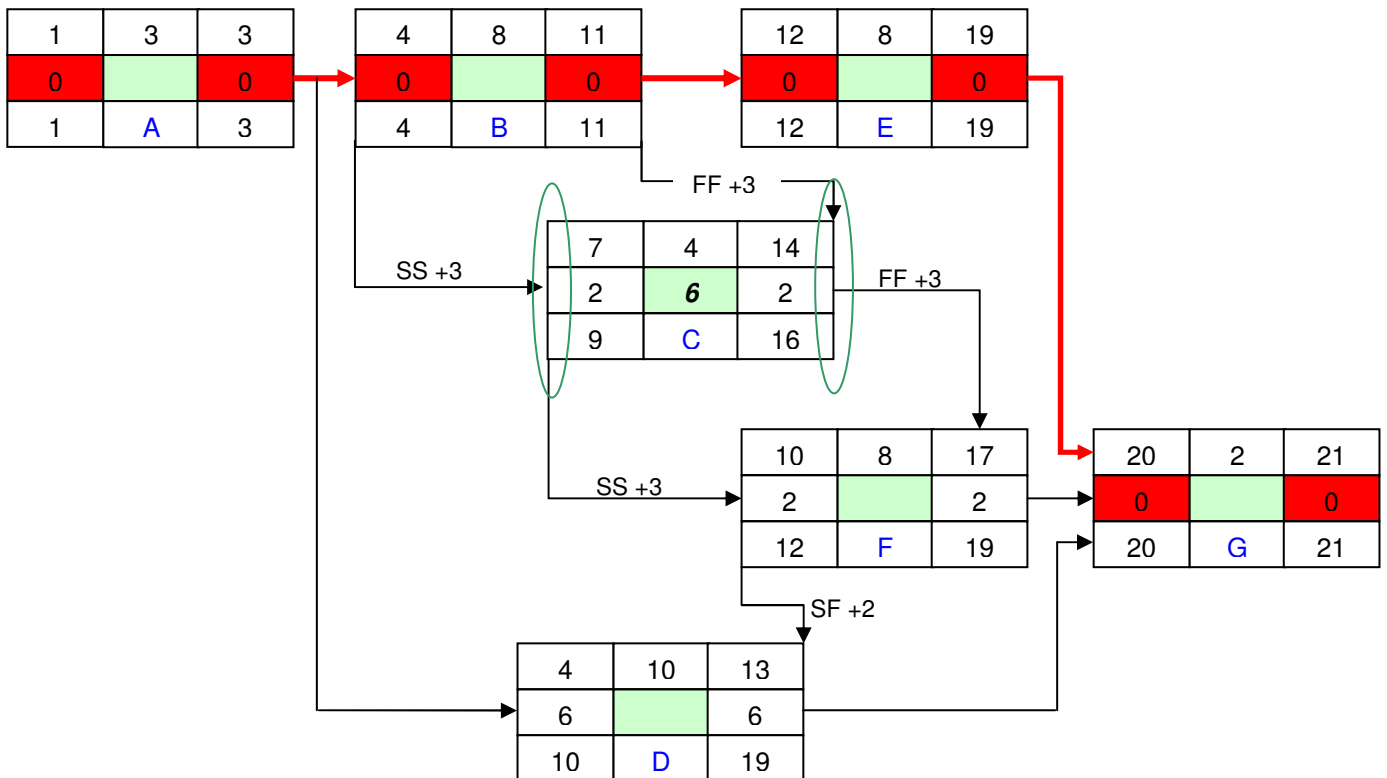

Model 2 uses a newer analytical approach based in part on concepts derived from the Arrow Diagramming Method (ADM) of CPM. The PDM activity is seen as three components, a zero duration start event, the work of the activity and a zero duration end event. The duration represents the minimum possible time between the start and the end event.

Using this analytical approach, the completion of Activity C is still controlled by the Finish-to-Finish link from 'B', but its start and the flow through to the start of 'F' is controlled by the Start-to-Start links. The work of the activity is assumed to occur on a progressive basis 'as needed'¹⁵.

The total amount of float available to the work of Activity C is $(LFT-EST) - Dur + 1 = (16 - 7) - 4 + 1 = 6$ days Activity Float. Whilst there is 2 days Total Float on the start event (TFE) and 2 days Total Float on the end event (TFL), the overall activity has 6 days float¹⁶.

¹⁵ This type of 'stretchable' activity is called non-contiguous, interruptible, elastic, can-split and stretchable depending on the software tool. The precise characteristics of the calculations vary.

¹⁶ For more on Float see, **Schedule Float**: http://www.mosaicprojects.com.au/Planning.html#Core_Papers



Activity D is also affected - in Model 1, its 'early' timing is controlled by the SF +3 link from F. In Model 2, the FS link from A is the control.

This approach to schedule analysis is embedded in the Relationship Diagramming variation of the Critical Path Method¹⁷ of schedule analysis developed by Fredric L. Plotnick and is approximated by making the activity durations 'interruptible' in scheduling tools such as Primavera.

Discussion: The core issue for planners and managers assessing a schedule is that both the overall project duration and the critical path have changed simply by altering the way the schedule is analysed. There are many similar 'switches' embedded in most sophisticated scheduling tools, and as a consequence to fully understand a schedule you need access to the original data on the original computer with all of the switches set in the same way. Printouts and data files are no longer sufficient even if you have the same software as the other party.

This paper is a core reference in our PMI-SP and PTMC credential courses.

For more information on these courses see:

http://www.mosaicprojects.com.au/Training-Planning_One-on-One.html

References:

Guide to Good Practice in the Management of Time in Complex Projects (The Guide):

http://www.mosaicprojects.com.au/Book_Sales.html#CIOB

The Practice Standard for Scheduling (PMI):

http://www.mosaicprojects.com.au/Book_Sales.html#PMI

The papers in this series:

- A Guide to Scheduling Good Practice:
http://www.mosaicprojects.com.au/PDF/Good_Scheduling_Practice.pdf
- Attributes of a Scheduler: http://www.mosaicprojects.com.au/PDF/Attributes_of_a_Scheduler.pdf
- Dynamic Scheduling: http://www.mosaicprojects.com.au/PDF/Dynamic_Scheduling.pdf
- Links, Lags & Ladders: http://www.mosaicprojects.com.au/PDF/Links_Lags_Ladders.pdf
- Schedule Float: http://www.mosaicprojects.com.au/PDF/Schedule_Float.pdf
- Schedule Levels: http://www.mosaicprojects.com.au/PDF/Schedule_Levels.pdf
- Schedule Calculations: http://www.mosaicprojects.com.au/PDF/Schedule_Calculations.pdf

Additional information; see Mosaic's Scheduling Home page at:

<http://www.mosaicprojects.com.au/Planning.html>

¹⁷ For more on RDCPM® see: <http://www.rdcpm.com/>

